

KD 708

Hochdruck Plungerpumpe

P max. 75 kW

Die robuste Pumpe KD 708 ist in unterschiedlichen Antriebs- und Flüssigkeitsteil-Varianten erhältlich. Konzipiert für dünnflüssige Medien. Haupt-Einsatzgebiete in Industrie und Dienstleistung:



- Kanalreinigung
- Entzunderung
- Industrielle Höchstdruckreinigung
- Sonderanwendungen

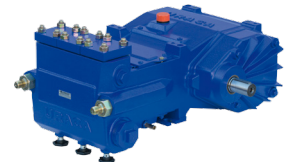

P max. 75 kW

The sturdy pump type KD708 is available in various drive and liquid end configurations. Designed for low viscous liquids. Main applications in industry and service sector:



- Sewer cleaning
- Descaling
- Industrial ultra-high pressure cleaning
- Special applications



Flüssigkeitsteile Liquid ends
Version A1, A2 Mit integrierten Stopfbuchsen. With integral stuffing boxes. 
Version C1 Edelstahl Ausführung mit Einzelstopfbuchsen. Stainless steel with single stuffing boxes. 
Klarwasserausführung. Clear water model.
Recyclingausführung. Recycling model.
Heisswasserausführung. Hot water model.
Ventilanhebung zur Entwässerung. Valve-lift for drainage.
Saugventilauflösung zur verschleißfreien Last-, Leerlaufumschaltung optional. Optional suction valve release for wear free load, unload change over.

Antrieb Drive
KD 708 Ohne integriertes Getriebe. Without integral gear. 
KD 708 G Mit integriertem Getriebe. With integral gear. 
KD 708 GS Mit um 180° gedrehtem Getriebe. With 180° rotated gear. 

Triebwerk Power ends
K Mit Spezial-Kreuzkopfabdichtung. With special crosshead sealing.
Triebwerkskühler entsprechend Einsatzbedingungen. Power end cooler subject to field of application.

Bauweise Design
Links- oder Rechtsausführung. Left or right hand drive.  
links/left rechts/right
Liegende Ausführung. In horizontal design. 

Technische Daten

Technical Data

Antriebsdrehzahl Drive speed			min ⁻¹			1000			1200			1500			1800			2100		2500
Getriebeübersetzung Gear ratio			i Getr. i gear			3,42	3,00	2,65	3,42	3,00	2,65	3,42	3,00	2,65	3,42	3,00	2,65	3,42	3,00	3,42
Pumpendrehzahl Pump speed			min ⁻¹			292	333	377	351	400	452	438	500	566	526	600	679	614	700	731
Version Version	Druck Pressure bar	Plunger Plunger Ø mm		Förderstrom Capacity						Antriebsleistung Power required										
				l/min (±2%)						kW (+3%)										
A1	135	55	l/min	122	138	156	145	165	186	181	205	231	215	245	275	250	283	295		
			kW	30	34	38	36	41	46	45	51	57	53	60	68	62	70	73		
	160	50	l/min	100	114	128	120	136	153	149	169	190	177	201	226	206	233	243		
			kW	29	33	38	35	40	45	44	49	56	52	59	66	60	68	71		
200	45	l/min	80	91	103	96	109	123	119	136	153	142	162	182	165	187	195			
		kW	29	34	38	35	40	45	44	50	56	52	59	67	61	69	72			
250	40	l/min	63	71	80	75	85	96	93	106	119	111	126	142	129	146	152			
		kW	29	33	37	34	39	44	43	48	54	51	58	65	59	67	70			
A2	250	40	l/min	63	71	80	75	85	96	93	106	119	111	126		129				
			kW	29	33	37	34	39	44	43	48	54	51	58		59				
	400	32	l/min	39,4	44,9	50,8	47,2	53,9	60,9	59	67,3	76,1	70,8	80,8		82,6				
kW			29	33	37	34	39	44	43	49	55	52	59		60					
C1	800	22	l/min	18,8	21,4	24,3	22,6	25,7	29,1	28,2	32,1	36,4	33,8	38,6	43,7	39,5	45	47		
			kW	27	31	35	33	37	42	41	47	53	50	57	64	58	66	69		
	1000	20	l/min	15,2	17,3	19,6	18,2	20,8	23,5	22,8	26	29,4	27,4	31,2	35,3	31,9	36,4	38		
kW			27	31	36	34	38	43	42	48	54	50	57	64	59	67	70			
1200	18	l/min	12,1	13,8	15,6	14,5	16,6	18,7	18,1	20,6	23,4	21,7	24,7	28,1	25,3	28,8	30,1			
		kW	26	30	34	32	36	41	40	45	51	48	54	61	56	63	66			

1 bar = 14,5038 psi; 1 l/min = 0,26417 USGPM = 0,22 IPGPM; 1 kW = 1,3410 HP; 1 mm = 0,03937 inch

Weitere technische Spezifikationen siehe Seite 4.

See page 4 for further technical specification.

Abmessungen

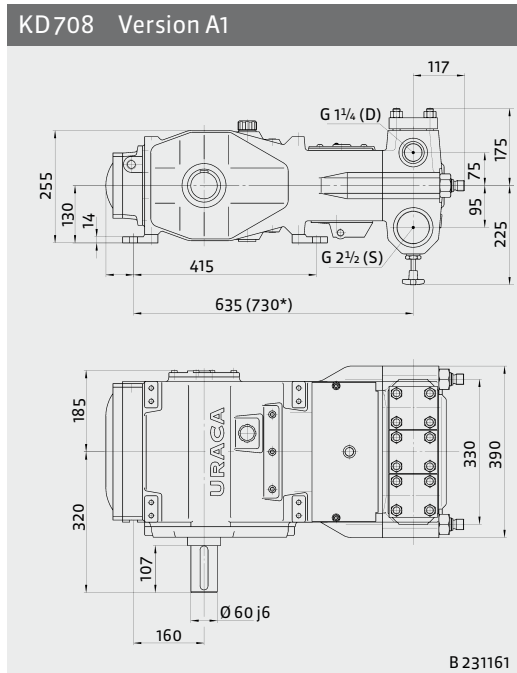

Dimensions

* Mit zusätzlicher Kreuzkopfabdichtung (K).
 Version C1 nur mit zus. Kreuzkopfabdichtung(K).
 D Druckanschluß
 S Sauganschluß

* Power end with add. crosshead sealing (K). Version C1
 are available with add. crosshead sealing only (K).
 D Pressure connection
 S Suction connection

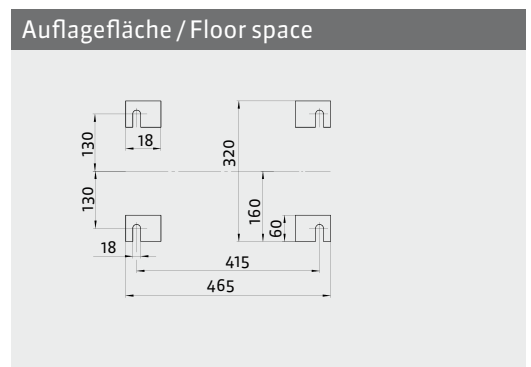
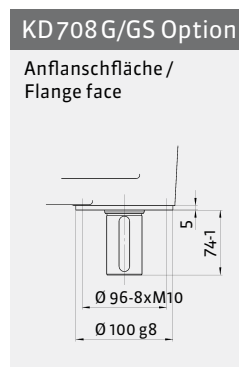
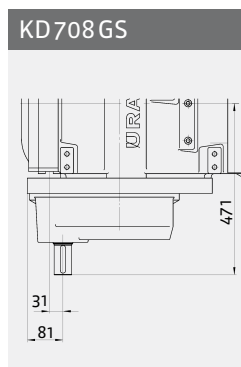
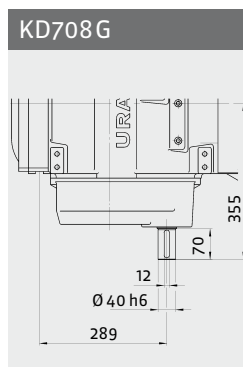
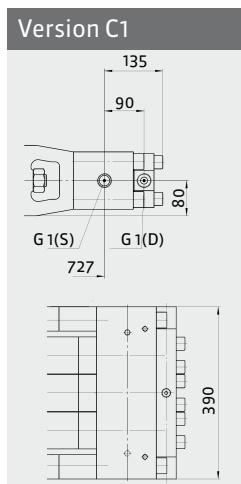
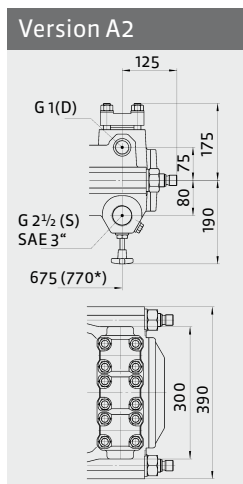

Gewichte

Ausführung Design	Gewicht (kg) Weight (kg)	Gewicht (lbs) Weight (lbs)
KD708 Version A1/A2	230	510
KD708G Version A1/A2	240	530
KD708GS Version A1/A2	255	560
KD708GK Version A1/A2	265	580
KD708GKS Version A1/A2	280	620

Gewichtsangaben ohne Öl, Abweichungen bedingt durch verschiedene Optionen möglich.

Weights

Ausführung Design	Gewicht (kg) Weight (kg)	Gewicht (lbs) Weight (lbs)
KD708K Version A1/A2	255	560
KD708GK Version C1	260	570
KD708GKS Version C1	275	610
KD708K Version C1	250	550

Weight without oil, differences are subject to different options.

Technische Spezifikationen

Hub = 60 mm

Zulässige externe Antriebswellenbelastung auf Anfrage.

Kurbelwellenüberlastsicherung optional.

Drehrichtung wählbar.

Die angegebenen Förderströme und Antriebsleistungen gelten für Wasser, volumetrische und mechanische Wirkungsgrade sind dabei berücksichtigt.

Ausführung des Flüssigkeitsteils abhängig von Fördermedium und Einsatzbedingungen.

Andere Betriebsdaten und detaillierte Abmessungen auf Anfrage.

Leistungsdaten für intermittierenden Betrieb; Daten für Dauereinsatz auf Anfrage.

Konstruktionsbedingt sind Drehzahleinschränkungen bei verschiedenen Druckstufen notwendig.

Erforderliche Zulaufdrücke sind abhängig von Einsatzbedingungen und Pumpenausführung.

Saug- und Druckanschlüsse sowie Antrieb wahlweise links oder rechts möglich.

Technical Specification

Stroke = 60 mm

Admissible external shaft loads upon request.

Optional crankshaft overload protection.

Direction of rotation selectable.

Capacity and recommended motor ratings as mentioned apply to water, the average volumetric and mechanical efficiency are taken into consideration.

Liquid end design depends on liquid handled and operation conditions.

Other operating data and detailed dimensions are available on request.

Data are for intermittent operation. Data for continuous operation are available on request.

Speed limitation at different pressure stages is due to design.

The required suction pressure depends on application and pump design.

Suction and discharge connections are available on either side. If required, drive shaft may be supplied on opposite side.

Konstruktionsänderungen vorbehalten. Maße, Gewichte, Abbildungen und Daten unverbindlich.

Design may be subject to modification. Dimensions, weights, illustrations and technical data are without engagement.