

KD 719

Hochdruck Plungerpumpe

P max. 110 kW

Die robuste Pumpe KD 719 ist in unterschiedlichen Antriebs- und Flüssigkeitsteil-Varianten erhältlich. Konzipiert für dünnflüssige Medien. Haupt-Einsatzgebiete in Industrie und Dienstleistung:

- Entzunderung
- Industrielle Hochdruckreinigung
- Sonderanwendungen

High pressure reciprocating plunger pump



P max. 110 kW

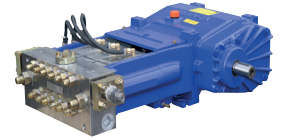

The sturdy pump type KD 719 is available in various drive and liquid end configurations. Designed for low viscous liquids. Main applications in industry and service sector:

- Descaling
- Industrial high pressure cleaning
- Special applications



Flüssigkeitsteile Liquid ends
Version A3, B, C, D Edelstahlausführung mit Einzelstopfbuchsen. Stainless steel with single stuffing boxes. 
Klarwasserausführung. Clear water model.
Heisswasserausführung. Hot water model.
Ventilanhebung zur Entwässerung (A3). Valve-lift for drainage (A3).
Saugventilauflösung zur verschleißfreien Last-, Leerlaufumschaltung optional. Optional suction valve release for wear free load, unload change over.

Antrieb Drive
KD 719 Ohne integriertes Getriebe. Without integral gear. 
KD 719 G Mit integriertem Getriebe. With integral gear. 
KD 719 H Anflanschfläche für Kupplungslaterne am Getriebegehäuse. Surface mounting at gear box for coupling housing. 

Bauweise Design
Links- oder Rechtsausführung. Left or right hand drive.   links/left rechts/right
Liegende Ausführung. In horizontal design. 

Triebwerk Power ends
Mit integrierter Kreuzkopfabdichtung (Standard). With integrated crosshead sealing (standard).
Triebwerkskühler entsprechend Einsatzbedingungen. Power end cooler subject to field of application.

Technische Daten

Technical Data

Antriebsdrehzahl Drive speed			min ⁻¹	1000			1200			1500			1800		2100	2200	
Getriebeübersetzung Gear ratio			i Getr. i gear	3,89	3,32	2,62	3,89	3,32	2,62	3,89	3,32	2,62	3,89	3,32	3,89	3,89	
Pumpendrehzahl Pump speed			min ⁻¹	257	301	382	308	362	459	385	452	574	462	542	539	565	
Version Version	Druck Pressure bar	Plunger Plunger Ø mm		Förderstrom Capacity						Antriebsleistung Power required							
				l/min (±2%)						kW (+3%)							
A3	170	60	l/min	150	176	223	180	211	268	225	264	335	270	317	315	330	
			kW	46,5	55	69	56	66	83	70	82	104	84	98	98	102	
	200	55	l/min	125	147	186	150	176	223	187	220	279	225	264	262	275	
			kW	45,5	54	68	55	64	81	68	80	102	82	96	96	100	
	240	50	l/min	102	120	152	122	144	182	153	180	228	184	216	214	224	
			kW	44,5	52	66	54	63	80	67	79	100	80	94	94	98	
	300	45	l/min	81	95	121	97	114	145	121	143	181	146	171	170	178	
			kW	44	52	66	53	62	79	66	78	99	80	93	93	97	
	380	40	l/min	62	73	92	74	87	111	93	109	138	111	131	130	136	
kW			42,5	50	64	51	60	76	64	75	95	77	90	90	94		
420	35	l/min	46	54	68	55	64	82	69	81	102	82	97	96	101		
		kW	35	41	52	42	49	62	52	61	78	63	74	73	77		
420	32	l/min	37	43,5	55	44,5	52	66	56	65	83	67	78	78	82		
		kW	28,5	33	42	34	40	51	42,5	50	63	51	60	59	62		
420	28	l/min	27,5	32	40,5	33	38,5	49	41	48	61	49	58	57	60		
		kW	21	24,5	31	25	29,5	37	31,5	36,5	46,5	37,5	44	44	46		
B	500	35	l/min	49,5	58	74	59	70	89	74	87	111	89	105	104	109	
			kW	45	53	67	54	63	80	67	79	100	81	95	94	99	
	600	32	l/min	41	48	61	49	57	73	61	72	91	73	86	86	90	
			kW	44	52	66	53	62	79	66	78	99	79	93	93	97	
	800	28	l/min	30,5	35,5	45	36,5	42,5	54	45,5	53	68	55	64	64	67	
			kW	43,5	51	65	52	61	78	65	77	97	78	92	91	96	
850	25	l/min	24	28	35,5	28,5	33,5	42,5	35,5	42	53	43	50	50	52		
		kW	36,5	42,5	54	43,5	51	65	54	64	81	65	77	76	80		
850	22	l/min	18,2	21,5	27	22	25,5	32,5	27,5	32	40,5	33	38,5	38,5	40		
		kW	28	32,5	41,5	33,5	39	49,5	41,5	49	62	50	59	58	61		
C	800	28	l/min	31,5	37	47	38	44,5	56	47	55	70	57	66	66	69	
			kW	45	53	67	54	64	81	68	80	101	81	96	95	100	
	1000	25	l/min	24,5	28,5	36,5	29,5	34,5	43,5	36,5	43	55	44	52	51	54	
kW			44	51	65	53	62	78	66	77	98	79	92	92	96		
D	1500	19	l/min	13,9	16,3	20,5	16,7	19,6	25	21	24,5	25	23	23	23,5		
			kW	37	43	55	44	52	66	55	65	66	66	66	66	66	
	2000	17	l/min	10,8	12,6	16	12,9	15,2	19,2	16,2	19	24	19,4	23	22,5	23,5	
			kW	37,5	44	56	45	53	67	56	66	84	68	79	79	83	
2500	15	l/min	8,3	9,8	12,4	10	11,7	14,9	12,5	14,7	15	15	15	15	15		
		kW	36	42	53	43	50	64	54	63	64	64	64	64	64		
2800	15	l/min	8,2	9,6	12,2	9,8	11,5	14,6	12,3	14,4	14,7	14,7	14,7	14,7	14,7		
		kW	39	46	58	47	55	70	59	69	69	69	69	69	69		

1 bar = 14,5038 psi; 1 l = 0,26417 USGPM = 0,22 IPGPM; 1 kW = 1,3410 HP; 1 mm = 0,03937 inch

Weitere technische Spezifikationen siehe Seite 4.

See page 4 for further technical specification.

Abmessungen

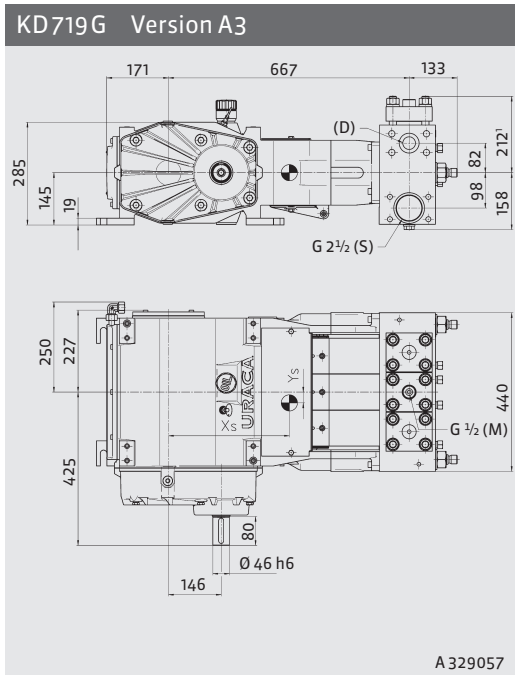

Dimensions

¹ Maß abhängig von Ausführung.
 D Druckanschluß
 S Sauganschluß
 M Manometeranschluß

¹ Dimensions depending on design.
 D Pressure connection
 S Suction connection
 M Pressure gauge connection

Auflagefläche / Floor space

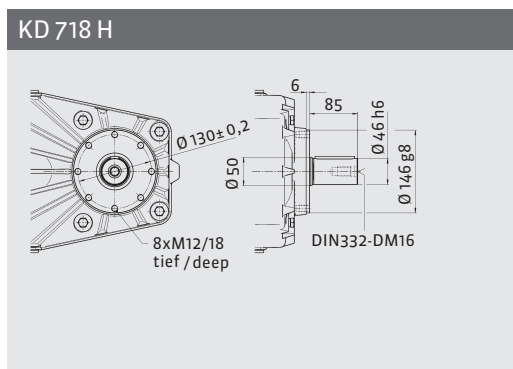
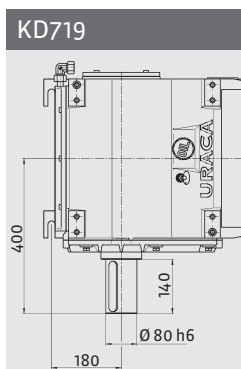
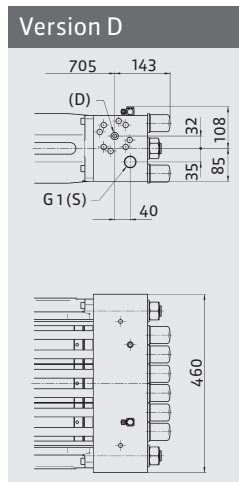
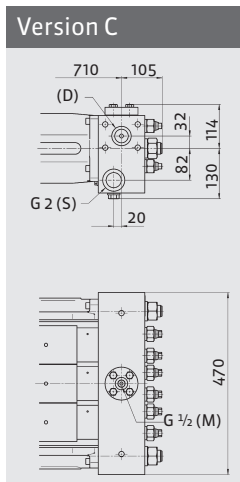
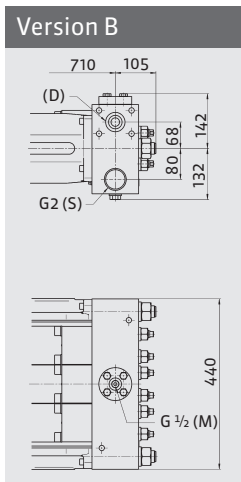
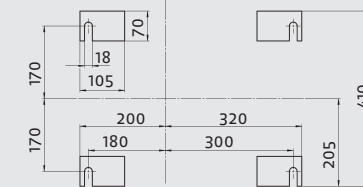

Gewichte

Ausführung Design		Gewicht (kg) Weight (kg)	Gewicht (lbs) Weight (lbs)
KD719	Version A3	375	830
KD719G	Version A3	400	880
KD719	Version B/C	365	810
KD719G	Version B/C	390	860
KD719	Version D	355	780
KD719G	Version D	380	840

Gewichtsangaben ohne Öl, Abweichungen bedingt durch verschiedene Optionen möglich.

Technische Spezifikationen

Hub = 70 mm

Zulässige externe Antriebswellenbelastung auf Anfrage.

Die angegebenen Förderströme und Antriebsleistungen gelten für Wasser, volumetrische und mechanische Wirkungsgrade sind dabei berücksichtigt.

Ausführung des Flüssigkeitsteils abhängig von Fördermedium und Einsatzbedingungen.

Andere Betriebsdaten und detaillierte Abmessungen auf Anfrage.

Leistungsdaten für intermittierenden Betrieb; Daten für Dauereinsatz auf Anfrage.

Konstruktionsbedingt sind Drehzahleinschränkungen bei verschiedenen Druckstufen notwendig.

Erforderliche Zulaufdrücke sind abhängig von Einsatzbedingungen und Pumpenausführung.

Saug- und Druckanschlüsse sowie Antrieb wahlweise links oder rechts möglich.

Konstruktionsänderungen vorbehalten. Maße, Gewichte, Abbildungen und Daten unverbindlich.

Weights

Weight without oil, differences are subject to different options.

Technical Specification

Stroke = 70 mm

Admissible external shaft loads upon request.

Capacity and recommended motor ratings as mentioned apply to water, the average volumetric and mechanical efficiency are taken into consideration.

Liquid end design depends on liquid handled and operation conditions.

Other operating data and detailed dimensions are available on request.

Data are for intermittent operation. Data for continuous operation are available on request.

Speed limitation at different pressure stages is due to design.

The required suction pressure depends on application and pump design.

Suction and discharge connections are available on either side. If required, drive shaft may be supplied on opposite side.

Design may be subject to modification. Dimensions, weights, illustrations and technical data are without engagement.