

# KD 716

## Hochdruck Plungerpumpe

P max. 110 kW

Die robuste Pumpe KD 716 ist in unterschiedlichen Antriebs- und Flüssigkeitsteil-Varianten erhältlich. Konzipiert für dünnflüssige Medien. Haupt-Einsatzgebiete in Industrie und Dienstleistung:

- Kanalreinigung
- Entzunderung
- Industrielle Hochdruckreinigung
- Sonderanwendungen

## High pressure reciprocating plunger pump



P max. 110 kW

The sturdy pump type KD 716 is available in various drive and liquid end configurations. Designed for low viscous liquids. Main applications in industry and service sector:

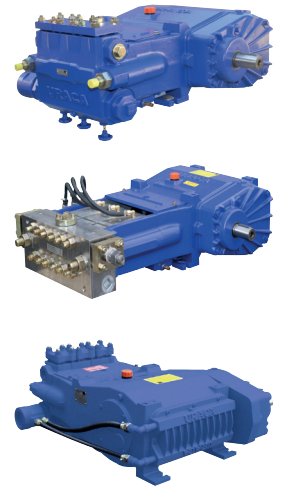
- Sewer cleaning
- Descaling
- Industrial high pressure cleaning
- Special applications

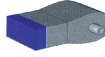
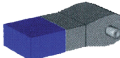

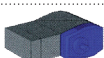
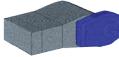
Flüssigkeitsteile Liquid ends
<b>Version A1, A2</b> Mit integrierten Stopfbuchsen. With integral stuffing boxes. 
<b>Version A3, B, C, D</b> Edelstahl Ausführung mit Einzelstopfbuchsen. Stainless steel with single stuffing boxes. 
Klarwasserausführung. Clear water model.
Recyclingausführung. Recycling model.
Heisswasserausführung. Hot water model.
Ventilanhebung zur Entwässerung. Valve-lift for drainage.
Saugventilauflösung zur verschleißfreien Last-, Leerlaufumschaltung optional. Optional suction valve release for wear free load, unload change over.

Antrieb Drive
<b>KD 716</b> Ohne integriertes Getriebe. Without integral gear. 
<b>KD 716 G</b> Mit integriertem Getriebe. With integral gear. 
<b>KD 716 GS</b> Mit um 180° gedrehtem Getriebe. With 180° rotated gear. 
<b>KD 716 H</b> Anflanschfläche für Kupplungslaterne an Getriebegehäuse. Surface mounting at gear box for coupling housing. 

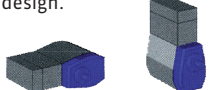
Bauweise Design
Links- oder Rechtsausführung. Left or right hand drive. 
links/left    rechts/right
Liegende oder stehende Ausführung. In horizontal or vertical design. 

Triebwerk Power ends
<b>Z</b> Mit Zwangsschmierung. With forced lubrication.
<b>K</b> Mit Spezial-Kreuzkopfabdichtung. With special crosshead sealing.
Triebwerkskühler entsprechend Einsatzbedingungen. Power end cooler subject to field of application.

Technische Daten

Technical Data

Antriebsdrehzahl Drive speed			min <sup>-1</sup>	1000			1200			1500			1800		2100	2200
Getriebeübersetzung Gear ratio			i Getr. i gear	3,90	3,32	2,62	3,90	3,32	2,62	3,90	3,32	2,62	3,90	3,32	3,90	3,90
Pumpendrehzahl Pump speed			min <sup>-1</sup>	257	301	382	308	362	459	385	452	574	462	542	539	565
Version Version	Druck Pressure bar	Plunger Plunger Ø mm		Förderstrom Capacity						Antriebsleistung Power required						
				l/min (±2%)						kW (+3%)						
A 1	140	65	l/min kW	176 47	206 55	261 69	211 56	247 65	313 83	263 70	309 82	391 104	316 84	370 98	369 98	387 103
	170	60	l/min kW	150 48	175 56	222 71	179 57	210 67	267 85	224 71	263 84	333 106	269 86	315 100	314 100	329 105
	200	55	l/min kW	123 46	144 54	183 68	148 55	173 65	219 82	185 69	216 81	274 103	222 83	260 97	259 97	271 102
A 2	270	45	l/min kW	81 41	95 48	120 61	97 49	113 57	144 73	121 61	142 72	180 91	145 77	170 86	169 86	177 90
	340	40	l/min kW	62 40	73 47	93 59	75 48	88 56	111 71	94 60	110 70	139 88	112 72	132 84	131 83	137 87
	530	32	l/min kW	39 37	46 44	58 55	47 45	55 52	69 67	58 56	68 66	87 83	70 67	82 79	81 78	85 82
A 3	170	60	l/min kW	150 46	176 55	223 69	180 56	211 65	268 83	225 70	264 82	335 104	270 84	317 98	315 98	330 102
	200	55	l/min kW	125 46	147 54	186 68	150 55	176 64	223 82	188 68	220 80	279 102	225 82	264 96	263 96	275 100
	250	50	l/min kW	102 47	120 55	152 69	123 56	144 66	183 83	153 70	180 82	228 104	184 84	216 98	215 98	225 102
	300	45	l/min kW	81 44	95 52	121 66	97 53	114 62	145 79	122 66	143 78	181 99	146 80	171 94	170 93	178 98
	380	40	l/min kW	62 43	73 50	92 64	75 51	87 60	111 77	93 64	109 76	139 96	112 77	131 91	130 90	137 94
	400	35	l/min kW	46 33	54 39	68 50	55 40	65 47	82 60	69 50	81 59	102 74	83 60	97 70	96 70	101 73
	400	32	l/min kW	37,5 27	44 32	56 40	45 33	53 38	67 48	56 41	66 48	83 61	67 49	79 57	78 57	82 60
	400	28	l/min kW	27 20	32 23	40 29	33 24	38 28	48 35	41 30	48 35	61 44	49 35	57 42	57 41	60 43
B	500	35	l/min kW	49,5 45	58 53	74 67	59 54	70 63	89 80	74 67	87 79	111 100	89 81	105 95	104 94	109 99
	600	32	l/min kW	41 44	48 52	61 66	49 53	57 62	73 79	61 66	72 78	91 99	73 80	86 94	86 93	90 97
	780	28	l/min kW	30 42	35,5 50	45 63	36,5 51	42,5 60	54 76	45,5 64	53 75	68 95	54 76	64 90	63 89	66 93
	850	25	l/min kW	23,5 36	27,5 42	35 53	28 43	33 50	42 64	35 54	41,5 63	53 80	42 64	49,5 76	49 75	52 79
C	780	28	l/min kW	31,5 44	36,5 52	46,5 65	37,5 53	44 62	56 79	47 66	55 77	70 98	57 79	66 93	66 92	69 97
	980	25	l/min kW	24,5 43	28,5 50	36,5 64	29,5 51	34,5 60	43,5 77	36,5 64	43 76	54 96	44 77	52 91	51 90	54 94
	1200	22	l/min kW	18,4 39	21,5 46	27,5 59	22 47	26 56	33 70	27,5 59	32,5 69	41 88	33 71	39 83	38,5 83	40,5 87
D	1500	19	l/min kW	14 37	16,5 44	21 56	16,8 45	19,8 53	25 67	21 56	24,5 66		25 67			
	2000	17	l/min kW	10,6 37	12,5 44	15,9 55	12,8 45	15 52	19 67	16 56	18,7 66	24 83	19,2 67	22,5 79	22,5 78	23,5 82
	2500	15	l/min kW	8,3 36	9,8 42	12,4 54	10 43	11,7 51	14,9 64	12,5 54	14,7 63		15 65			
	2800	15	l/min kW	8,2 39	9,6 46	12,2 59	9,8 47	11,5 55	14,6 70	12,3 59	14,4 69		14,7 71			

1 bar = 14,5038 psi; 1 l = 0,26417 USGPM = 0,22 IPGPM; 1 kW = 1,3410 HP; 1 mm = 0,03937 inch

Weitere technische Spezifikationen siehe Seite 4.

See page 4 for further technical specification.

## Abmessungen

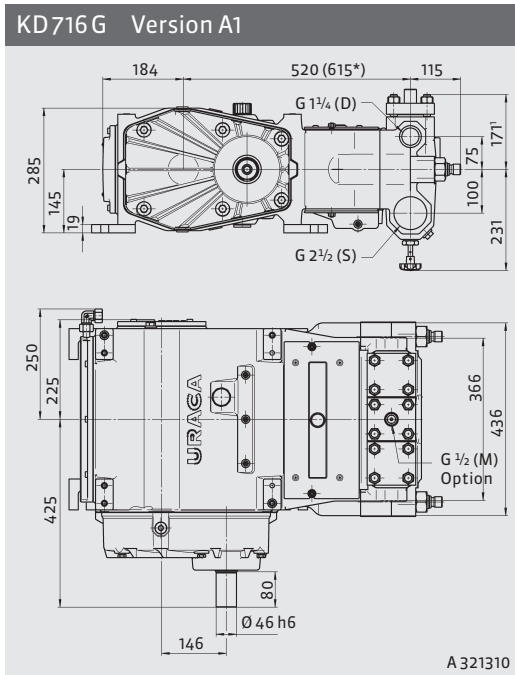

## Dimensions

- <sup>1</sup> Maß abhängig von Ausführung.  
 \* Mit zusätzlicher Kreuzkopfabdichtung (K).  
 Version A3 und D nur mit zus. Kreuzkopfabdichtung(K).  
 D Druckanschluß  
 S Sauganschluß  
 M Manometeranschluß
- <sup>1</sup> Dimensions depending on design.  
 \* Power end with add. crosshead sealing (K). Version A3 and D are available with add. crosshead sealing only (K).  
 D Pressure connection  
 S Suction connection  
 M Pressure gauge connection

Version A2	A	B	C	F	D	S
Plg. Ø 32	590 (685*)	95 (115*)	75	82	G1	G2
Plg. Ø 40/Ø 45	612 (707*)	93 (93*)	70	82	G1 1/4	G2
Plg. Ø 55	590(685*)	95 (115*)	70	90	G1 1/4	G2 1/2

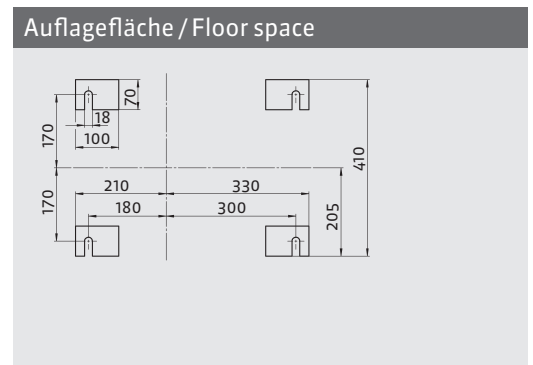
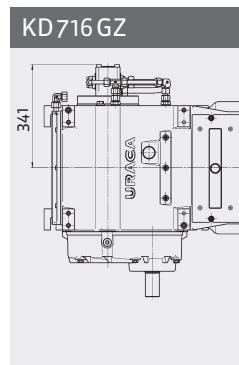
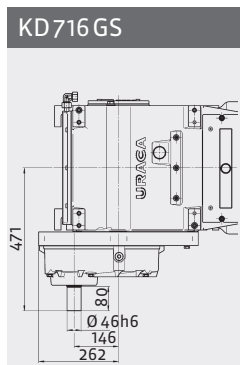
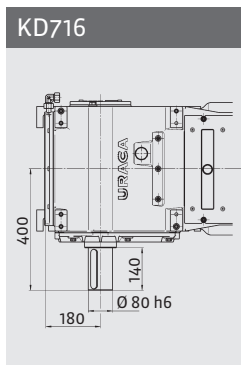
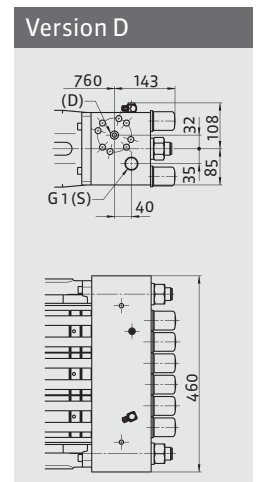
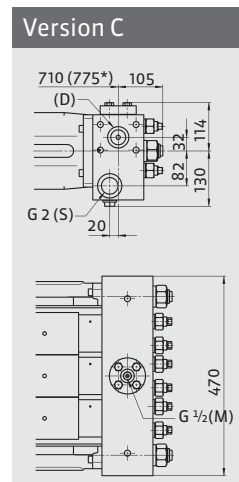
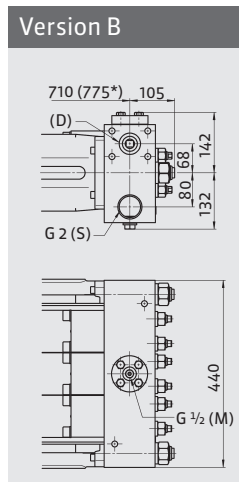
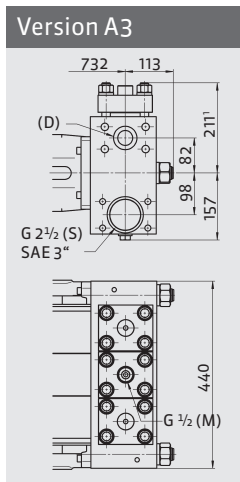
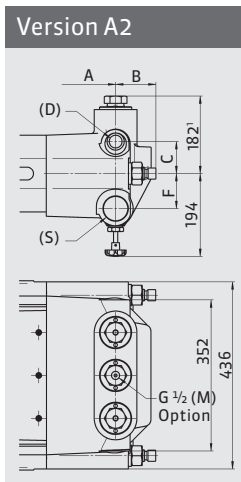

## Gewichte

Ausführung Design	Gewicht (kg) Weight (kg)	Gewicht (lbs) Weight (lbs)
KD716 G Version A1	325	715
KD716 G Version A2	350	770
KD716 GK Version A3	425	935
KD716 G Version B	415	915
KD716 G Version C	415	915
KD716 GK Version D	410	905

Gewichtsangaben ohne Öl, Abweichungen bedingt durch verschiedene Optionen möglich.

## Technische Spezifikationen

Hub = 70 mm

Zulässige externe Antriebswellenbelastung auf Anfrage.

Zwangsschmierung optional  
(G- und GK-Ausführung).

Die angegebenen Förderströme und Antriebsleistungen gelten für Wasser, volumetrische und mechanische Wirkungsgrade sind dabei berücksichtigt.

Ausführung des Flüssigkeitsteils abhängig von Fördermedium und Einsatzbedingungen.

Andere Betriebsdaten und detaillierte Abmessungen auf Anfrage.

Leistungsdaten für intermittierenden Betrieb; Daten für Dauereinsatz auf Anfrage.

Konstruktionsbedingt sind Drehzahleinschränkungen bei verschiedenen Druckstufen notwendig.

Erforderliche Zulaufdrücke sind abhängig von Einsatzbedingungen und Pumpenausführung.

Saug- und Druckanschlüsse sowie Antrieb wahlweise links oder rechts möglich.

Konstruktionsänderungen vorbehalten. Maße, Gewichte, Abbildungen und Daten unverbindlich.

## Weights

Weight without oil, differences are subject to different options.

## Technical Specification

Stroke = 70 mm

Admissible external shaft loads upon request.

Forced lubrication optional  
(G- and GK-version).

Capacity and recommended motor ratings as mentioned apply to water, the average volumetric and mechanical efficiency are taken into consideration.

Liquid end design depends on liquid handled and operation conditions.

Other operating data and detailed dimensions are available on request.

Data are for intermittent operation. Data for continuous operation are available on request.

Speed limitation at different pressure stages is due to design.

The required suction pressure depends on application and pump design.

Suction and discharge connections are available on either side. If required, drive shaft may be supplied on opposite side.

Design may be subject to modification. Dimensions, weights, illustrations and technical data are without engagement.