

# KD 718

## Hochdruck Plungerpumpe

P max. 110 kW

Die robuste Pumpe KD 718 ist in unterschiedlichen Antriebs- und Flüssigkeitsteil-Varianten erhältlich. Konzipiert für dünnflüssige Medien. Haupt-Einsatzgebiete in Industrie und Dienstleistung:

- Kanalreinigung
- Sonderanwendungen

## High pressure reciprocating plunger pump



P max. 110 kW

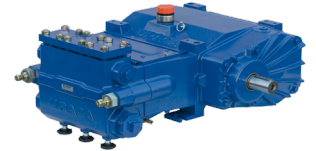

The sturdy pump type KD 718 is available in various drive and liquid end configurations. Designed for low viscous liquids. Main applications in industry and service sector:

- Sewer cleaning
- Special applications

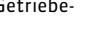

Flüssigkeitsteile Liquid ends
<b>Version A1, A2</b> Mit integrierten Stopfbuchsen. With integral stuffing boxes. 
Klarwasserausführung. Clear water model.
Recyclingausführung. Recycling model.
Heisswasserausführung. Hot water model.
Ventilanhebung zur Entwässerung. Valve-lift for drainage.
Saugventilauflösung zur verschleißfreien Last-, Leerlaufumschaltung optional. Optional suction valve release for wear free load, unload change over.

Antrieb Drive
<b>KD 718</b> Ohne integriertes Getriebe. Without integral gear. 
<b>KD 718 G</b> Mit integriertem Getriebe. With integral gear. 
<b>KD 718 GS</b> Mit um 180° gedrehtem Getriebe. With 180° rotated gear. 
<b>KD 718 H</b> Anflanschfläche für Kupplungslaterne am Getriebegehäuse. Surface mounting at gear box for coupling housing. 

Bauweise Design
Links- oder Rechtsausführung. Left or right hand drive. 
links/left    rechts/right
Liegende Ausführung. In horizontal design. 

Triebwerk Power ends
Mit integrierter Kreuzkopfabdichtung (Standard). With integrated crosshead sealing (standard).
Triebwerkskühler entsprechend Einsatzbedingungen. Power end cooler subject to field of application.

Technische Daten

Technical Data

Antriebsdrehzahl Drive speed			min <sup>-1</sup>	1000			1200			1500			1800		2100	2200
Getriebeübersetzung Gear ratio			i Getr. i gear	3,89	3,32	2,62	3,89	3,32	2,62	3,89	3,32	2,62	3,89	3,32	3,89	3,89
Pumpendrehzahl Pump speed			min <sup>-1</sup>	257	301	382	308	362	459	385	452	574	462	542	539	565
Version	Druck Pressure bar	Plunger Plunger Ø mm		Förderstrom Capacity						Antriebsleistung Power required						
Version				l/min (±2%)						kW (+3%)						
A 1	125	70	l/min	204	240	304	245	288	365	306	360		368	432	429	
			kW	46,5	55	69	56	66	83	70	82		84	99	98	
	145	65	l/min	175	206	261	210	247	313	263	309	392	316	370	368	386
			kW	46,5	54	69	56	65	83	70	82	104	84	98	97	102
A 2	170	60	l/min	150	175	222	179	210	267	224	263	333	269	315	314	329
			kW	46,5	54	69	56	65	83	69	82	103	83	98	97	102
	200	55	l/min	123	145	184	148	174	220	185	217	275	222	260	259	271
			kW	45	53	67	54	63	80	67	79	100	81	95	94	99
A 2	200	55	l/min	123	144	183	148	173	220	184	217	275	221	260	258	271
			kW	45	53	67	54	63	80	67	79	100	81	95	94	99
	300	45	l/min	80	94	119	96	113	143	120	141	179	144	169	168	176
			kW	43,5	51	65	52	62	78	66	77	98	79	92	92	96
A 2	340	40	l/min	62	73	93	75	88	112	94	110	140	112	132	131	137
			kW	38,5	45,5	57	46,5	54	69	58	68	86	69	82	81	85
A 2	530	32	l/min	37,5	44	56	45	53	67	56	66	84	68	79	79	83
			kW	36	42,5	54	43,5	51	64	54	64	81	65	76	76	79

1 bar = 14,5038 psi; 1 l = 0,26417 USGPM = 0,22 IPGPM; 1 kW = 1,3410 HP; 1 mm = 0,03937 inch

Weitere technische Spezifikationen siehe Seite 4.

See page 4 for further technical specification.

## Abmessungen

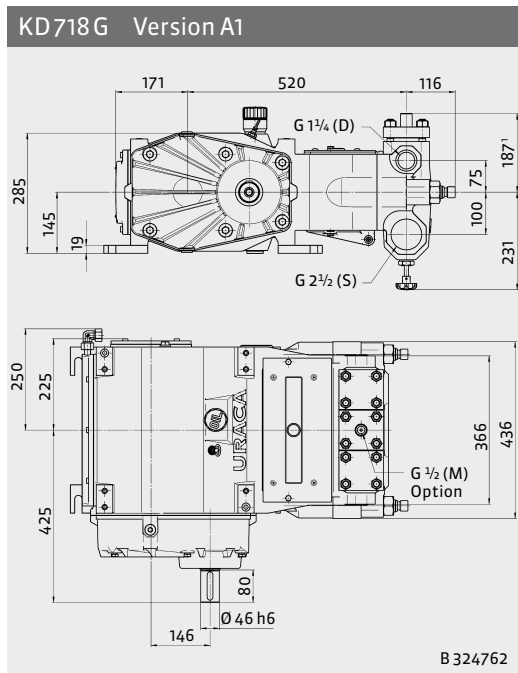

## Dimensions

<sup>1</sup> Maß abhängig von Ausführung.

D Druckanschluss  
S Sauganschluss  
M Manometeranschluss

<sup>1</sup> Dimensions depending on design.

D Pressure connection  
S Suction connection  
M Pressure gauge connection

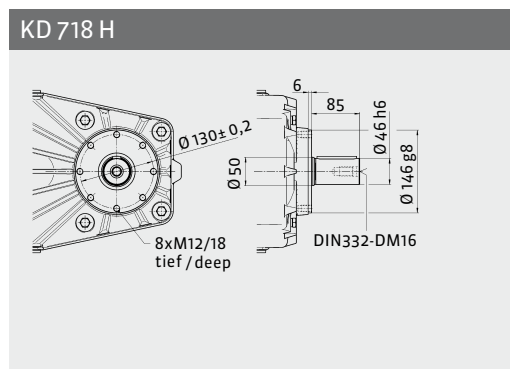
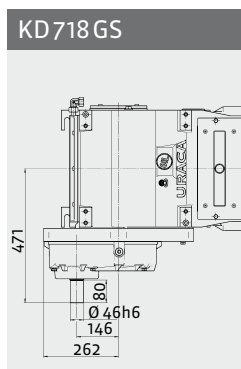
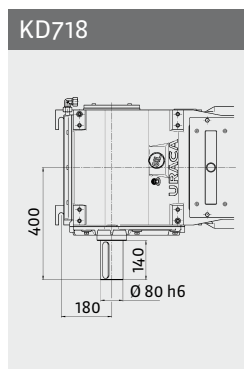
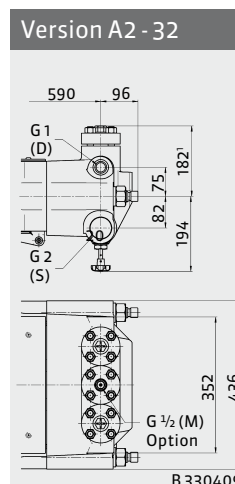
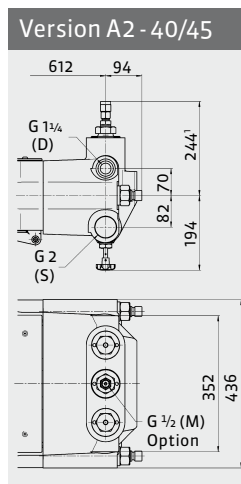
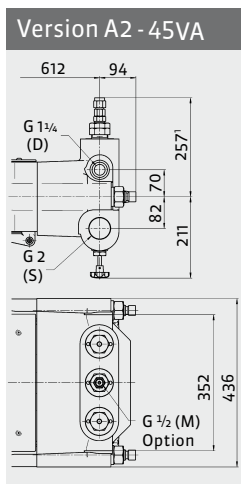
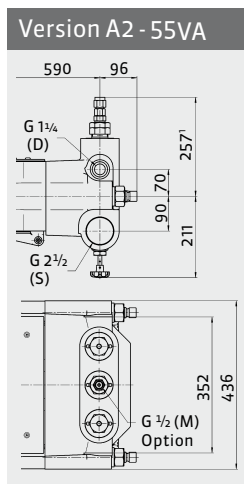
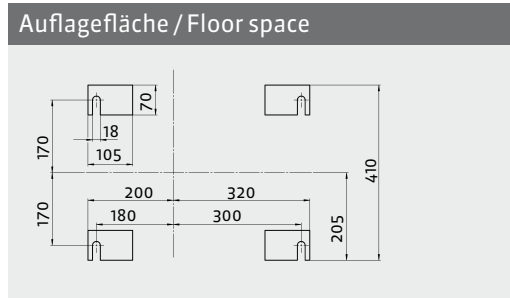

## Gewichte

Ausführung Design		Gewicht (kg) Weight (kg)	Gewicht (lbs) Weight (lbs)
KD718	Version A1	276	610
KD718G	Version A1	299	660
KD718GS	Version A1	335	740
KD718	Version A2	303	670
KD718G	Version A2	326	720
KD718GS	Version A2	362	800

Gewichtsangaben ohne Öl, Abweichungen bedingt durch verschiedene Optionen möglich.

## Technische Spezifikationen

Hub = 70 mm

Zulässige externe Antriebswellenbelastung auf Anfrage.

Die angegebenen Förderströme und Antriebsleistungen gelten für Wasser, volumetrische und mechanische Wirkungsgrade sind dabei berücksichtigt.

Ausführung des Flüssigkeitsteils abhängig von Fördermedium und Einsatzbedingungen.

Andere Betriebsdaten und detaillierte Abmessungen auf Anfrage.

Leistungsdaten für intermittierenden Betrieb; Daten für Dauereinsatz auf Anfrage.

Konstruktionsbedingt sind Drehzahleinschränkungen bei verschiedenen Druckstufen notwendig.

Erforderliche Zulaufdrücke sind abhängig von Einsatzbedingungen und Pumpenausführung.

Saug- und Druckanschlüsse sowie Antrieb wahlweise links oder rechts möglich.

Konstruktionsänderungen vorbehalten. Maße, Gewichte, Abbildungen und Daten unverbindlich.

## Weights

Weight without oil, differences are subject to different options.

## Technical Specification

Stroke = 70 mm

Admissible external shaft loads upon request.

Capacity and recommended motor ratings as mentioned apply to water, the average volumetric and mechanical efficiency are taken into consideration.

Liquid end design depends on liquid handled and operation conditions.

Other operating data and detailed dimensions are available on request.

Data are for intermittent operation. Data for continuous operation are available on request.

Speed limitation at different pressure stages is due to design.

The required suction pressure depends on application and pump design.

Suction and discharge connections are available on either side. If required, drive shaft may be supplied on opposite side.

Design may be subject to modification. Dimensions, weights, illustrations and technical data are without engagement.